

RSL SERIES - POLE TOP MOUNT

SOLAR LED INTEGRATED COMMERCIAL AREA LIGHT

Project: _____

Type: _____ Quantity: _____



The RSL Series solar LED round luminaire is a versatile lighting solution designed for a variety of spaces, from commercial and parking lot spaces to recreational bikeways and public areas. Its self-contained design flawlessly integrates solar power, adaptive control, and LED technologies into a compact, efficient form. With its sturdy construction and outstanding performance, the RSL series delivers cost-effective, full-cutoff lighting wherever it's required.

Using solar power and LEDs, the RSL series is completely self-contained and offers significant benefits:

- Cost-effective design ships fully assembled and installs in minutes
- Wireless control & communication with your light
- Low installation cost and minimal site impact with no trenching, cabling or wiring
- Minimal ongoing costs with no electrical bills or bulbs to change
- Operates entirely independent from the grid and is immune to power outages
- A sustainable choice without recurring carbon emissions

All of our solar powered lights are enabled by our innovative Solar Lighting Controller (SLC). The SLC in each light is “self-learning” and allows the lights to predictively adapt to their surroundings, providing a level of lighting performance and reliability unavailable in other solar lighting products.

TECHNICAL SPECIFICATIONS

- Solar Module:**
- High-efficiency monocrystalline cells
 - Inconspicuously integrated into the top of luminaire
 - Used for day/night detection (no photocell required)

- Solar Lighting Controller (SLC):**
- Microcontroller-based technology
 - High-efficiency, Maximum Power Point Tracking (MPPT) battery charger
 - Built-in high-efficiency LED driver
 - Multiyear data logging
 - Automatically manages lighting performance based on environmental conditions and lighting requirements
 - Integrated into luminaire housing

- Battery:**
- High performance lithium (LiFePO₄)
 - Exceptional 10+ year lifecycle
 - High temperature tolerance
 - Contained within luminaire housing
 - Designed for easy battery changes when required

- Wireless Controls:**
- Easy-to-use interface via iOS smartphone app
 - Configure and control lighting profiles
 - Adjust dusk and dawn thresholds
 - Motion sensing capabilities optimize performance based on usage

- LEDs and Optics:**
- 100,000 hour L70 lifetime LED
 - Extra Warm White (2700K), Warm White (3000K), Neutral White (4000K), and Amber (595nm) LEDs available
 - High-efficiency type 2, 3, 4, 4F, and 5, full cutoff optics
 - Typical lumen output 3250 lumens
 - Optional backlight shield
 - Wildlife-friendly amber option available

- Mechanical Construction:**
- Yoke Mount option allows easy mounting to a vertical tenon
 - Die-cast aluminum
 - Toolless access
 - Stainless fasteners
 - Architectural grade, super durable, TGIC powder coat
 - Four standard colors with custom colors available

- Factory Set Lighting Profiles:**
- 11 standard duration profiles available
 - Real-time lighting profile options available
 - See lighting profile sheet for all options
 - Lighting profiles and motion sensing options are field configurable with app
 - Motion sensing capabilities optimize performance based on usage

SOLAR LED INTEGRATED COMMERCIAL AREA LIGHT

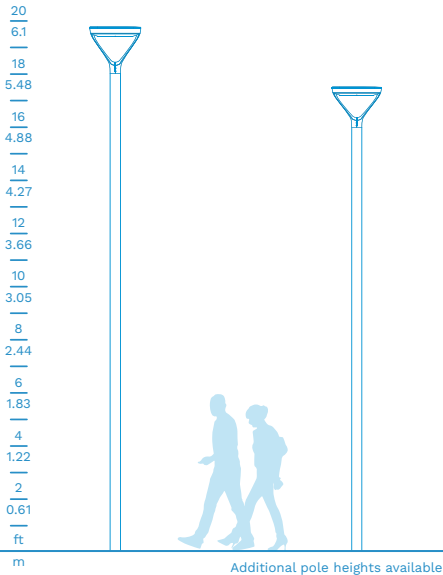

Top Tenon Mount Luminaire Weight: 41.04 lbs (18.62 kg)
Solar Engine EPA: 0.52 ft² (0.048 m²)
Solar Engine and Mount EPA: 0.68 ft² (0.063 m²)

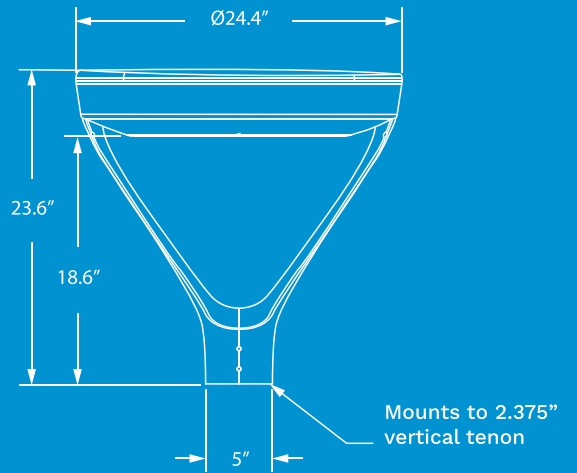
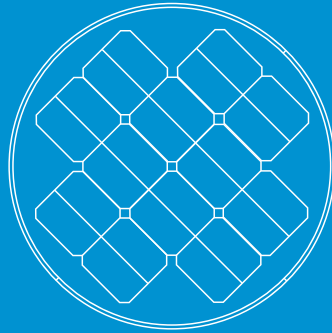

PHOTOMETRICS (IES files available on our website)

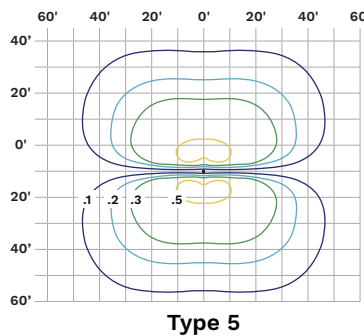
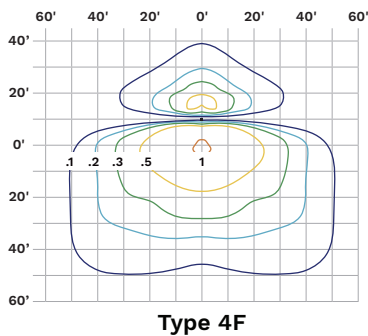
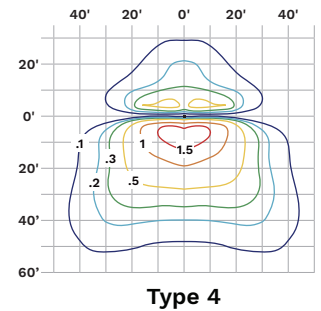
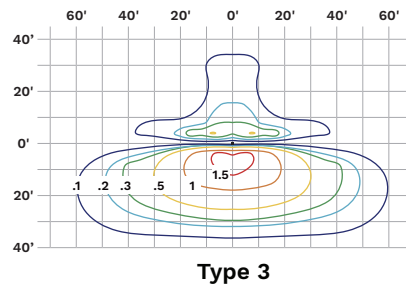
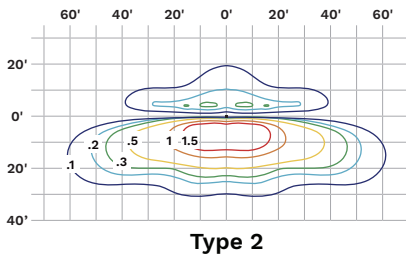

Notes:

- Photometrics based on 20 ft mounting height
- Light levels in foot candles are calculated using 3250 lumens at 4000K color temperature
- To convert to lux multiply light levels by 10.7
- Typical lumen levels based off of Type 5 optic with the default profile using neutral white LEDs
- Contact us for help in choosing the right lighting profile and distribution
- Motion sensing is ON by default
- Specifications subject to change without notice

ORDER MATRIX



Series	Mounting	Finish	Optic	Distribution	LED	Lighting Profiles (full list on website)	Options
RSL	CM - Cleat Mount	BK - Black	ST - Standard	T2 - Type 2	XW - 2700K	00 - Dusk till dawn	SEC - Security Fasteners
		BZ - Bronze		T3 - Type 3	WW - 3000K	09 - On at dusk, 100% for 3 hours, dim to 30%, brighten to 100% one hour before dawn, off at dawn (DEFAULT)	MSO - Motion Sensor Off
	TM - Tenon Mount	SV - Silver		T4 - Type 4	NW - 4000K		BLS - Backlight Shield
	PTM - Pole Top Mount	WH - White		T4F - Type 4F	AMB - Amber	TX0000 - On at dusk until time between 1800 & 0600. X = O (Off) or D (Dim). 0000 = time to dim or turn off.	BLB - Blue Light Blocker
		CC - Custom		T5 - Type 5			