

Project: _____

Type: _____ Quantity: _____



The PLB series solar powered LED bollard is ideal for architectural and commercial pathway applications. The self-contained, stylish, contemporary design combined with high quality construction and unequalled solar powered performance make the PLB series an excellent fit where quality lighting is required.

Utilizing solar power and LED lighting the PLB bollards are fully self contained and offer significant benefits over typical wired bollards:

- Low installed costs and minimal site impacts with no trenching, cabling or wiring
- Minimal ongoing costs with no electricity bills or bulbs to change
- Immune from power outages
- A sustainable choice without recurring carbon emissions

All of our solar powered lights are enabled by our innovative Solar Lighting Controller (SLC). The SLC in each light is “self-learning” and allows the lights to predictively adapt to their surroundings, providing a level of lighting performance and reliability unavailable in other solar lighting products.

TECHNICAL SPECIFICATIONS

- Solar Module:**
- High impact, UV resistant encapsulation
 - High-efficiency mono-crystalline cells
 - Integrated into bollard housing
 - Used for day/night detection (no photocell required)

- Solar Lighting Controller (SLC):**
- High efficiency Maximum Power Point Tracking (MPPT) charge controller
 - Micro-controller based technology
 - Includes high-efficiency LED driver
 - Integrated into bollard housing
 - Designed to automatically manage lighting performance based on environmental conditions and lighting requirements
 - Patent pending

- Battery:**
- High performance Lithium (LiFePO₄)
 - Exceptional 8 – 10 year life cycle
 - High temperature tolerance
 - Contained within bollard post
 - Designed for easy battery changes when required

- LEDs and Optics:**
- High output Cree LEDs
 - 100,000 hour L70 lifetime
 - Warm (3000K) and neutral (4500K) white color temperatures available
 - Type III and Type V high efficiency, cut-off optics
 - Typical lumen output of 220 - 300 lumens

- Mechanical Construction:**
- Cast, low copper aluminum housing
 - Extruded, low copper aluminum post
 - Stainless fasteners with security fastener option
 - High strength mounting base
 - Architectural grade, super durable, TGIC powder coat
 - Four standard colors with custom colors available

- Factory Set Lighting Profiles:**
- On at dusk, off at dawn
 - On at dusk, turn off after 6 hours
 - On at dusk, dim to 30% after 6 hours till dawn
 - On at dusk, off after 5 hours, on 1 hour before dawn
 - On at dusk, dim to 30% after 5 hours, on 1 hour before dawn

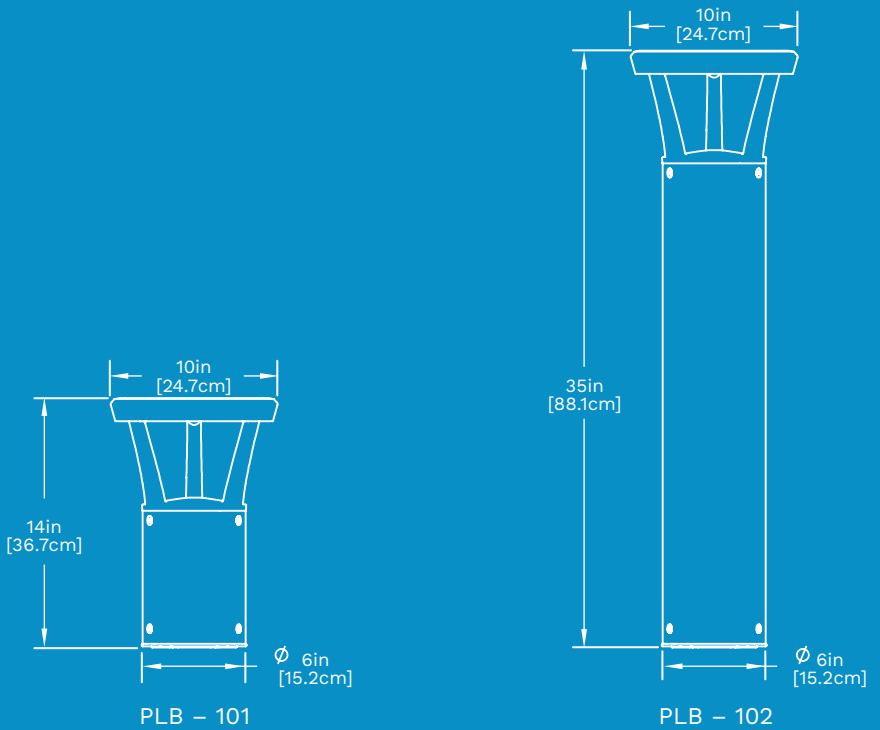
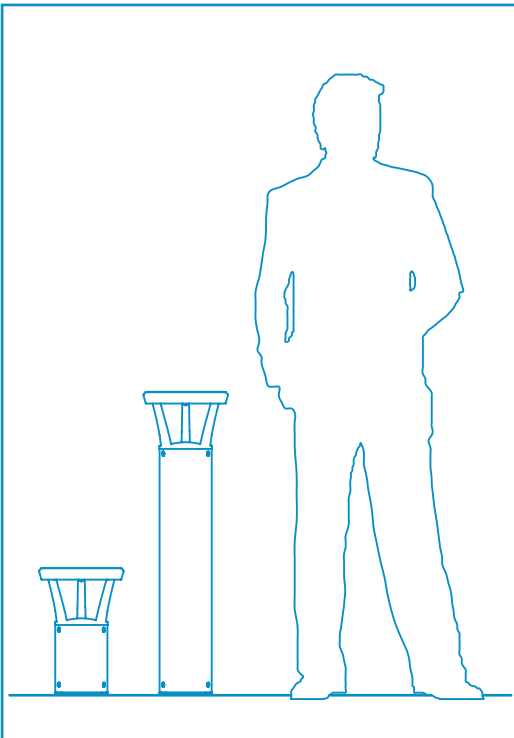

PHOTOMETRICS (IES files available on request)

If you have any questions, please don't hesitate to call us toll free at 1-844-279-8754 (USA & Canada).

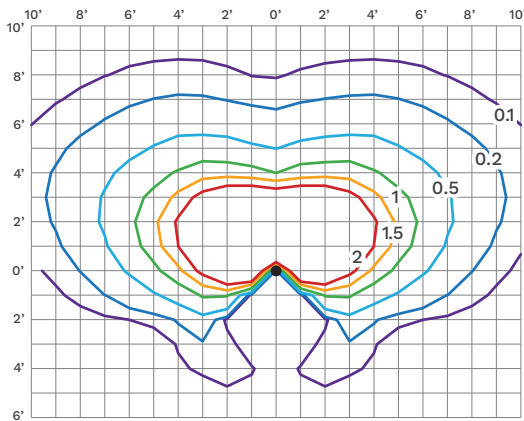

PLB102 - Type 3

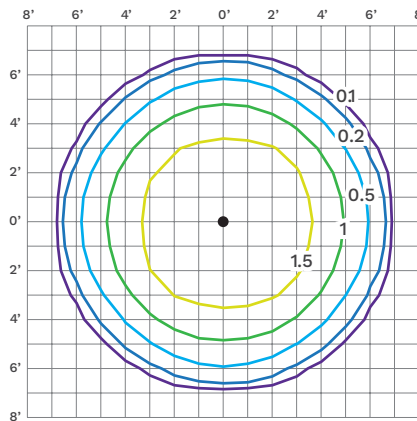

PLB102 - Type 5

Represented by:

ORDER MATRIX

Series	Height	Finish	Distribution	LED Color	Lighting Profile	Options
PLB	101 - 14"	BK - Black	ASM - Type 3	WW - 3000K	00 - Dusk till dawn	SEC - Security Fasteners
	102 - 35"	BZ - Bronze	SYM - Type 5	NW - 4500K	01 - Dark +6 hours then off	PA - Pre-Ship Anchor Bolts
		SV - Silver			02 - Dark +6 hours then 30%	
		WH - White			03 - Dark +5 hours, off, Dawn -1 hour	
		CC - Custom			04 - Dark +5 hours, 30%, Dawn -1 hour (DEFAULT)	

Notes:
 - Specifications subject to change without notice
 - All light levels in foot candles (fc) with 4500K color temperature and 160 lumen output
 - To convert to lux multiply light level by 10.7

