

Project: \_\_\_\_\_

Type: \_\_\_\_\_

Quantity: \_\_\_\_\_

The SCL2 Series solar LED luminaire is a great fit for commercial, parking lot, recreational bikeway/pathway and public space lighting applications. The self-contained, unobtrusive design integrates its solar power, adaptive control and LED technologies into a compact and efficient form. With robust construction, and unequalled performance the SCL2 series is an excellent fit wherever cost effective, full cutoff lighting is required.

Utilizing solar power and LEDs, the SCL2 series is completely self-contained and offers significant benefits:

- Cost effective design ships fully assembled and installs in minutes
- Smart Connect provides wireless control & communication with your light
- Low installation cost and minimal site impact with no trenching, cabling or wiring
- Minimal ongoing costs with no electrical bills or bulbs to change
- Operates entirely independent from the grid and is immune to power outages
- A sustainable choice without recurring carbon emissions

All of our solar powered lights are enabled by our innovative Solar Lighting Controller (SLC). The SLC in each light is “self-learning” and allows the lights to predictively adapt to their surroundings, providing an unsurpassed level of lighting performance and reliability.

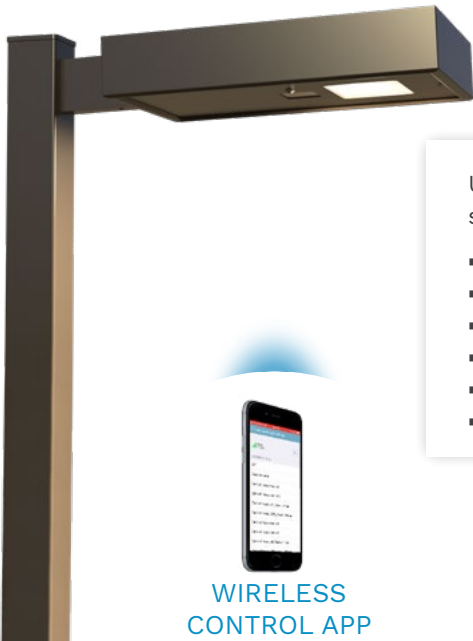

## TECHNICAL SPECIFICATIONS

- Solar Module:**
- High-efficiency mono-crystalline cells
  - Inconspicuously integrated into the top of luminaire
  - Used for day/night detection (no photocell required)

- Solar Lighting Controller (SLC):**
- High-efficiency, temperature compensated maximum power point tracking (MPPT)
  - Micro-controller based technology
  - Includes high-efficiency LED driver
  - Multiyear data logging
  - Integrated into luminaire housing
  - Designed to automatically and adaptively manage lighting performance based on environmental conditions and lighting requirements
  - Patent Pending

- Battery:**
- High performance lithium (LiFePO<sub>4</sub>)
  - Exceptional 8 – 10 year life cycle
  - High temperature tolerance
  - Contained within luminaire housing
  - Designed for easy battery changes when required

- LEDs and Optics:**
- 100,000 hour L70 lifetime
  - Warm (3000K) and neutral (4500K) white color temperatures available
  - High efficiency Type 2, 3, 4 and 5, full cut-off optics
  - Typical lumen output from 2250 to 2830 lumens

- Mechanical Construction:**
- Extruded and formed, low copper aluminum enclosure, and mounting arm
  - Stainless fasteners with security fastener option
  - Architectural grade, super durable, TGIC powder coat
  - Four standard colors with custom colors available

- Factory Set Lighting Profiles:**
- 11 standard duration profiles available
  - Real-time lighting profile options available
  - See lighting profile sheet for all options
  - Lighting profiles and motion sensing options are field configurable with app
  - Motion sensing capabilities optimise performance based on usage

- Wireless Controls:**
- Bluetooth low energy interface with iOS app
  - Provide configuration and control of lighting profiles
  - Adjustment over dusk and dawn thresholds

EPA: 0.99ft<sup>2</sup> (0.09m<sup>2</sup>)

Weight: 34 lbs (15.4kg) including battery

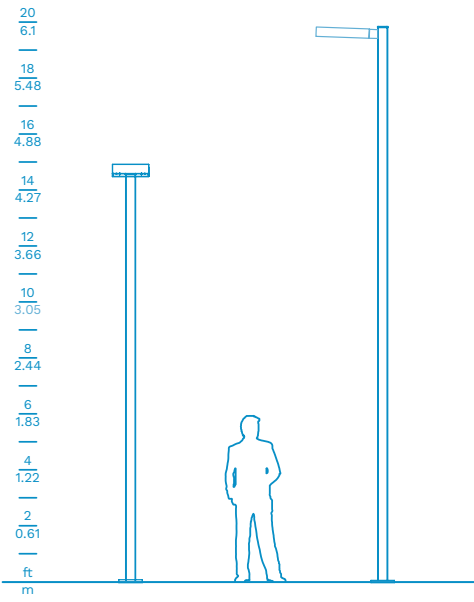
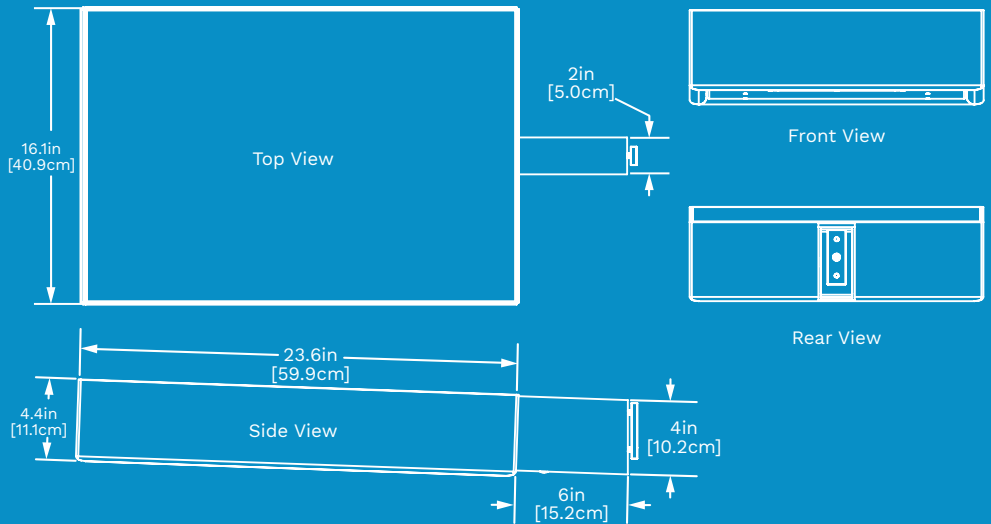

### PHOTOMETRICS (IES files available on request)

If you have any questions, please don't hesitate to call us toll free at 1-844-279-8754 (USA & Canada).

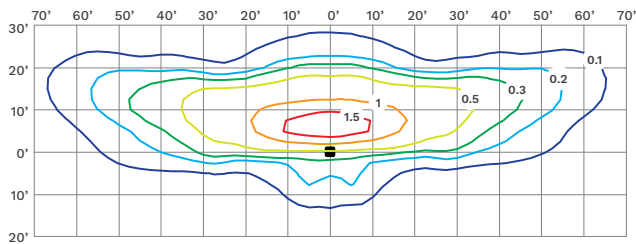

SCL2 - Type 2

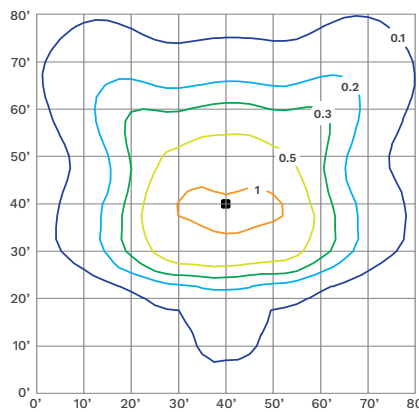

SCL2 - Type 4

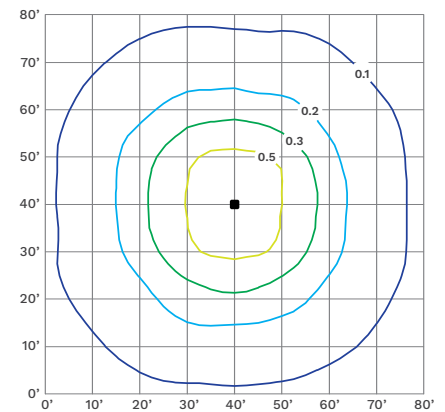

SCL2 - Type 5

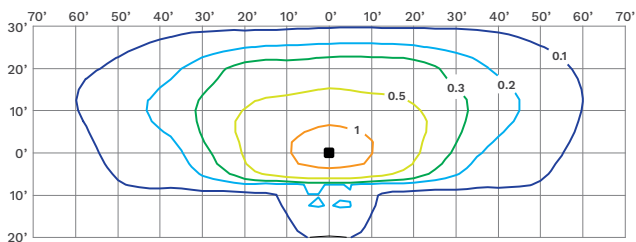

SCL2 - Type 3

### ORDER MATRIX

Series	Mounting	Finish	Distribution	LED Color	Lighting Profiles (See Profile Sheet)	Options
SCL2	SPMS - Side Pole Mount Square	BK - Black	T2 - Type 2	WW - 3000K	00 - Dusk till dawn	SEC - Security Fasteners
	SPMR - Side Pole Mount Round	BZ - Bronze	T3 - Type 3	NW - 4500K	09 - On at dusk, 100% for 3 hours, dim to 30%, brighten to 100% one hour before dawn, off at dawn (DEFAULT)	MSO - Motion Sense Off
	NMNT - No Mount	SV - Silver	T4 - Type 4			TX0000 - On at dusk until time between 1800 & 0600. X = O (Off) or D (Dim). 0000 = time to dim or turn off.
		WH - White	T5 - Type 5			
		CC - Custom				

- Notes:
- Photometrics based on 20 ft mounting height
  - All light levels in foot candles (fc) with 4500K color temperature and 2000 lumen output
  - To convert to lux multiply light level by 10.7
  - Contact FLT for help choosing the right lighting profile
  - Motion sensing is ON by default
  - Specifications subject to change without notice

